

Chapter 6

Digital Design and Computer Architecture, 2nd Edition

David Money Harris and Sarah L. Harris

Chapter 6 :: Topics

- Introduction
- Assembly Language
- Machine Language
- Programming
- Addressing Modes
- Lights, Camera, Action: Compiling, Assembling, & Loading
- Odds and Ends

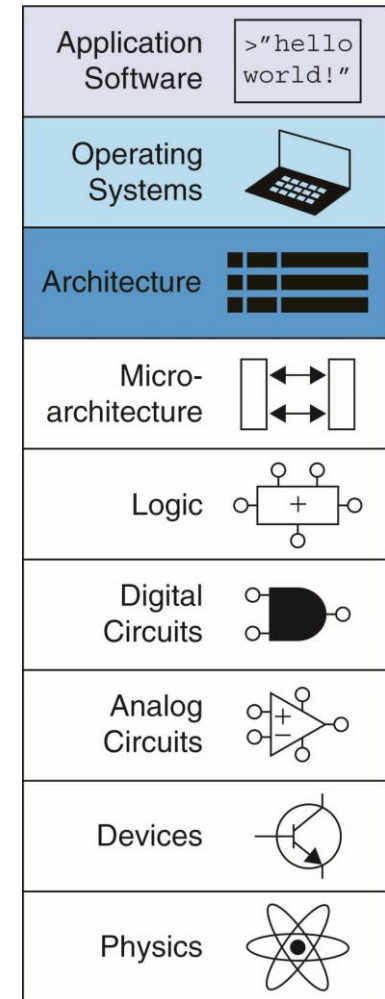

Introduction

- Jumping up a few levels of abstraction
- **Architecture:** programmer's view of computer
 - Defined by instructions & operand locations
- **Microarchitecture:** how to implement an architecture in hardware (covered in Chapter 7)

Application Software	programs
Operating Systems	device drivers
Architecture	instructions registers
Micro-architecture	datapaths controllers
Logic	adders memories
Digital Circuits	AND gates NOT gates
Analog Circuits	amplifiers filters
Devices	transistors diodes
Physics	electrons



Assembly Language

- **Instructions:** commands in a computer's language
 - **Assembly language:** human-readable format of instructions
 - **Machine language:** computer-readable format (1's and 0's)
- **MIPS architecture:**
 - Developed by John Hennessy and his colleagues at Stanford and in the 1980's.
 - Used in many commercial systems, including Silicon Graphics, Nintendo, and Cisco

Once you've learned one architecture, it's easy to learn others

John Hennessy

- President of Stanford University
- Professor of Electrical Engineering and Computer Science at Stanford since 1977
- Coinvented the Reduced Instruction Set Computer (RISC) with David Patterson
- Developed the MIPS architecture at Stanford in 1984 and cofounded MIPS Computer Systems
- As of 2004, over 300 million MIPS microprocessors have been sold



Architecture Design Principles

Underlying design principles, as articulated by Hennessy and Patterson:

1. **Simplicity favors regularity**
2. **Make the common case fast**
3. **Smaller is faster**
4. **Good design demands good compromises**

Instructions: Addition

C Code

```
a = b + c;
```

MIPS assembly code

```
add a, b, c
```

- **add:** mnemonic indicates operation to perform
- **b, c:** source operands (on which the operation is performed)
- **a:** destination operand (to which the result is written)

Instructions: Subtraction

- Similar to addition - only mnemonic changes

C Code

```
a = b - c;
```

MIPS assembly code

```
sub a, b, c
```

- **sub:** mnemonic
- **b, c:** source operands
- **a:** destination operand

Design Principle 1

Simplicity favors regularity

- Consistent instruction format
- Same number of operands (two sources and one destination)
- easier to encode and handle in hardware

Multiple Instructions

- More complex code is handled by multiple MIPS instructions.

C Code

```
a = b + c - d;
```

MIPS assembly code

```
add t, b, c    # t = b + c  
sub a, t, d    # a = t - d
```

Design Principle 2

Make the common case fast

- MIPS includes only simple, commonly used instructions
- Hardware to decode and execute instructions can be simple, small, and fast
- More complex instructions (that are less common) performed using multiple simple instructions
- MIPS is a *reduced instruction set computer (RISC)*, with a small number of simple instructions
- Other architectures, such as Intel's x86, are *complex instruction set computers (CISC)*

Operands

- Operand location: physical location in computer
 - Registers
 - Memory
 - Constants (also called *immediates*)

Operands: Registers

- MIPS has 32 32-bit registers
- Registers are faster than memory
- MIPS called “32-bit architecture” because it operates on 32-bit data

Design Principle 3

Smaller is Faster

- MIPS includes only a small number of registers

MIPS Register Set

Name	Register Number	Usage
\$0	0	the constant value 0
\$at	1	assembler temporary
\$v0-\$v1	2-3	Function return values
\$a0-\$a3	4-7	Function arguments
\$t0-\$t7	8-15	temporaries
\$s0-\$s7	16-23	saved variables
\$t8-\$t9	24-25	more temporaries
\$k0-\$k1	26-27	OS temporaries
\$gp	28	global pointer
\$sp	29	stack pointer
\$fp	30	frame pointer
\$ra	31	Function return address

Operands: Registers

- Registers:
 - \$ before name
 - Example: \$0, “register zero”, “dollar zero”
- Registers used for specific purposes:
 - \$0 always holds the constant value 0.
 - the *saved registers*, \$s0–\$s7, used to hold variables
 - the *temporary registers*, \$t0 - \$t9, used to hold intermediate values during a larger computation
 - Discuss others later

Instructions with Registers

- Revisit add instruction

C Code

```
a = b + c
```

MIPS assembly code

```
# $s0 = a, $s1 = b, $s2 = c  
add $s0, $s1, $s2
```

Operands: Memory

- Too much data to fit in only 32 registers
- Store more data in memory
- Memory is large, but slow
- Commonly used variables kept in registers

Word-Addressable Memory

- Each 32-bit data word has a unique address

Word Address	Data	
⋮	⋮	⋮
00000003	4 0 F 3 0 7 8 8	Word 3
00000002	0 1 E E 2 8 4 2	Word 2
00000001	F 2 F 1 A C 0 7	Word 1
00000000	A B C D E F 7 8	Word 0

Reading Word-Addressable Memory

- Memory read called *load*
- **Mnemonic:** *load word* (`lw`)
- **Format:**
`lw $s0, 5($t1)`
- **Address calculation:**
 - add *base address* (`$t1`) to the *offset* (5)
 - $\text{address} = (\$t1 + 5)$
- **Result:**
 - `$s0` holds the value at address $(\$t1 + 5)$

Any register may be used as base address

Reading Word-Addressable Memory

- **Example:** read a word of data at memory address 1 into `$s3`
 - address = (`$0` + 1) = 1
 - `$s3` = `0xF2F1AC07` after load

Assembly code

```
lw $s3, 1($0) # read memory word 1 into $s3
```

Word Address	Data	
⋮	⋮	⋮
00000003	4 0 F 3 0 7 8 8	Word 3
00000002	0 1 E E 2 8 4 2	Word 2
00000001	F 2 F 1 A C 0 7	Word 1
00000000	A B C D E F 7 8	Word 0

Writing Word-Addressable Memory

- Memory write are called *store*
- **Mnemonic:** *store word* (s_w)

Writing Word-Addressable Memory

Example: Write (store) the value in $\$t4$ into memory address 7

- add the base address ($\$0$) to the offset ($0x7$)
- address: $(\$0 + 0x7) = 7$

Offset can be written in decimal (default) or hexadecimal

Assembly code

```
sw $t4, 0x7($0) # write the value in $t4
                  # to memory word 7
```

Word Address	Data	
⋮	⋮	⋮
00000003	4 0 F 3 0 7 8 8	Word 3
00000002	0 1 E E 2 8 4 2	Word 2
00000001	F 2 F 1 A C 0 7	Word 1
00000000	A B C D E F 7 8	Word 0

Reading Byte-Addressable Memory

- The address of a memory word must now be multiplied by 4. For example,
 - the address of memory word 2 is $2 \times 4 = 8$
 - the address of memory word 10 is $10 \times 4 = 40$ (0x28)
- **MIPS is byte-addressed, not word-addressed**

Reading Byte-Addressable Memory

Example: Load a word of data at memory address 4 into `$s3`.

`$s3` holds the value `0xF2F1AC07` after load

MIPS assembly code

```
lw $s3, 4($0) # read word at address 4 into $s3
```

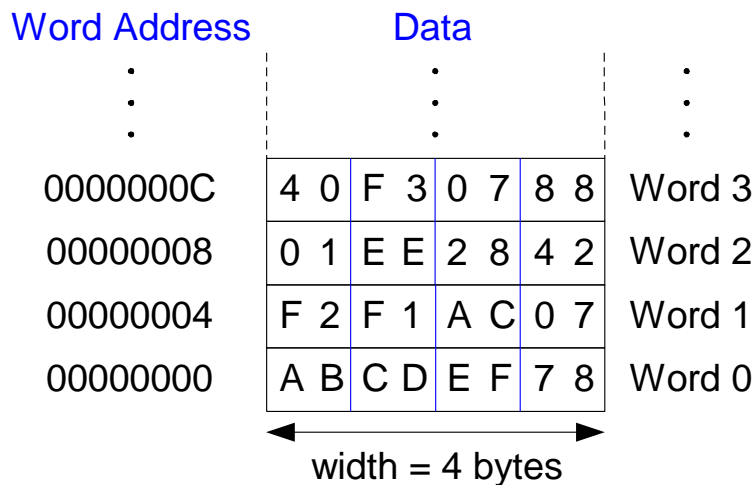

Writing Byte-Addressable Memory

- Example:** stores the value held in $\$t7$ into memory address $0x2C$ (44)

MIPS assembly code

```
sw $t7, 44($0) # write $t7 into address 44
```

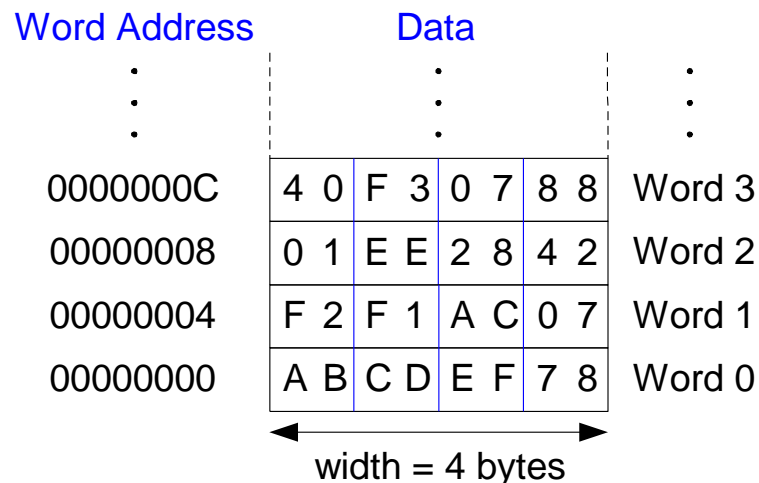

Big-Endian & Little-Endian Memory

- How to number bytes within a word?
- **Little-endian:** byte numbers start at the little (least significant) end
- **Big-endian:** byte numbers start at the big (most significant) end
- **Word address** is the **same** for big- or little-endian

Big-Endian

Byte Address			
⋮			
C	D	E	F
8	9	A	B
4	5	6	7
0	1	2	3

MSB LSB

Little-Endian

Byte Address			
⋮			
F	E	D	C
B	A	9	8
7	6	5	4
3	2	1	0

MSB LSB

Word Address
⋮
C
8
4
0

Big-Endian & Little-Endian Memory

- Jonathan Swift's *Gulliver's Travels*: the Little-Endians broke their eggs on the little end of the egg and the Big-Endians broke their eggs on the big end
- It doesn't really matter which addressing type used – except when the two systems need to share data!

Big-Endian

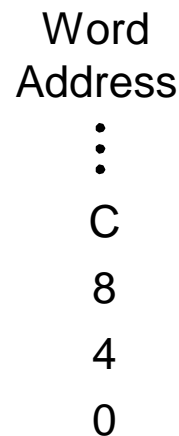
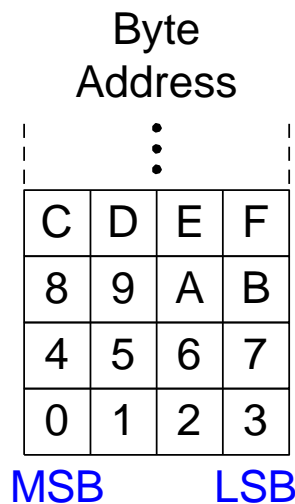

Little-Endian

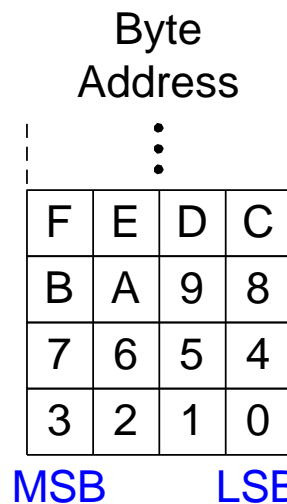

Big-Endian & Little-Endian Example

- Suppose `$t0` initially contains `0x23456789`
- After following code runs on big-endian system, what value is `$s0`?
- In a little-endian system?

```
sw $t0, 0($0)
```

```
lb $s0, 1($0)
```

Big-Endian & Little-Endian Example

- Suppose `$t0` initially contains `0x23456789`
- After following code runs on big-endian system, what value is `$s0`?
- In a little-endian system?

```
sw $t0, 0($0)
```

```
lb $s0, 1($0)
```

- Big-endian: `0x00000045`
- Little-endian: `0x00000067`

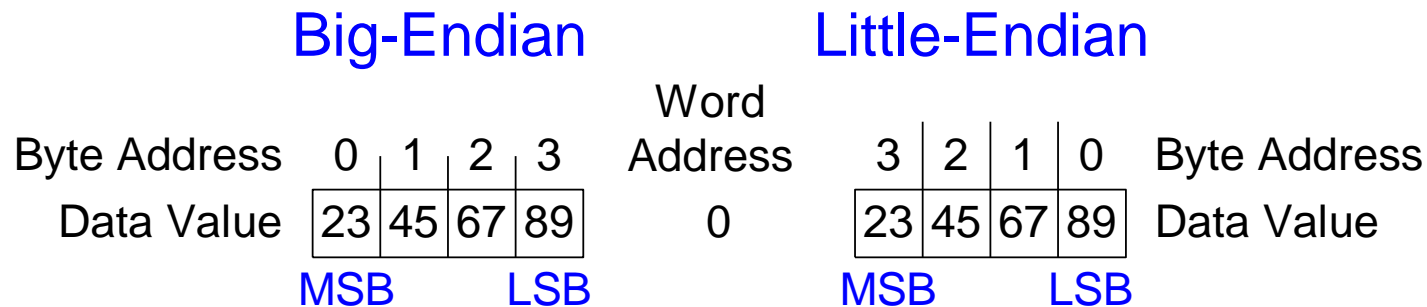

Design Principle 4

Good design demands good compromises

- Multiple instruction formats allow flexibility
 - add, sub: use 3 register operands
 - lw, sw: use 2 register operands and a constant
- Number of instruction formats kept small
 - to adhere to design principles 1 and 3 (simplicity favors regularity and smaller is faster).

Operands: Constants/Immediates

- `lw` and `sw` use constants or *immediates*
- *immediately* available from instruction
- 16-bit two's complement number
- `addi`: add immediate
- Subtract immediate (`subi`) necessary?

C Code

```
a = a + 4;  
b = a - 12;
```

MIPS assembly code

```
# $s0 = a, $s1 = b  
addi $s0, $s0, 4  
addi $s1, $s0, -12
```

Machine Language

- Binary representation of instructions
- Computers only understand 1's and 0's
- 32-bit instructions
 - Simplicity favors regularity: 32-bit data & instructions
- 3 instruction formats:
 - **R-Type**: register operands
 - **I-Type**: immediate operand
 - **J-Type**: for jumping (discuss later)

R-Type

- *Register-type*
- 3 register operands:
 - rs, rt: source registers
 - rd: destination register
- Other fields:
 - op: the *operation code* or *opcode* (0 for R-type instructions)
 - funct: the *function*
with opcode, tells computer what operation to perform
 - shamt: the *shift amount* for shift instructions, otherwise it's 0

R-Type

op	rs	rt	rd	shamt	funct
6 bits	5 bits	5 bits	5 bits	5 bits	6 bits

R-Type Examples

Assembly Code

```
add $s0, $s1, $s2
```

```
sub $t0, $t3, $t5
```

Field Values

op	rs	rt	rd	shamt	funct
0	17	18	16	0	32
0	11	13	8	0	34

6 bits 5 bits 5 bits 5 bits 5 bits 6 bits

Machine Code

op	rs	rt	rd	shamt	funct	
000000	10001	10010	10000	00000	100000	(0x02328020)
000000	01011	01101	01000	00000	100010	(0x016D4022)

6 bits 5 bits 5 bits 5 bits 5 bits 6 bits

Note the order of registers in the assembly code:

```
add rd, rs, rt
```

I-Type

- *Immediate-type*
- 3 operands:
 - *rs, rt*: register operands
 - *imm*: 16-bit two's complement immediate
- Other fields:
 - *op*: the opcode
 - Simplicity favors regularity: all instructions have opcode
 - Operation is completely determined by opcode

I-Type



I-Type Examples

Assembly Code

```
addi $s0, $s1, 5
addi $t0, $s3, -12
lw    $t2, 32($0)
sw    $s1, 4($t1)
```

Field Values

op	rs	rt	imm
8	17	16	5
8	19	8	-12
35	0	10	32
43	9	17	4

6 bits 5 bits 5 bits 16 bits

Note the differing order of registers in assembly and machine codes:

```
addi rt, rs, imm
lw    rt, imm(rs)
sw    rt, imm(rs)
```

Machine Code

op	rs	rt	imm	
001000	10001	10000	0000 0000 0000 0101	(0x22300005)
001000	10011	01000	1111 1111 1111 0100	(0x2268FFF4)
100011	00000	01010	0000 0000 0010 0000	(0x8C0A0020)
101011	01001	10001	0000 0000 0000 0100	(0xAD310004)

6 bits 5 bits 5 bits 16 bits

Machine Language: J-Type

- *Jump-type*
- 26-bit address operand (`addr`)
- Used for jump instructions (`j`)

J-Type

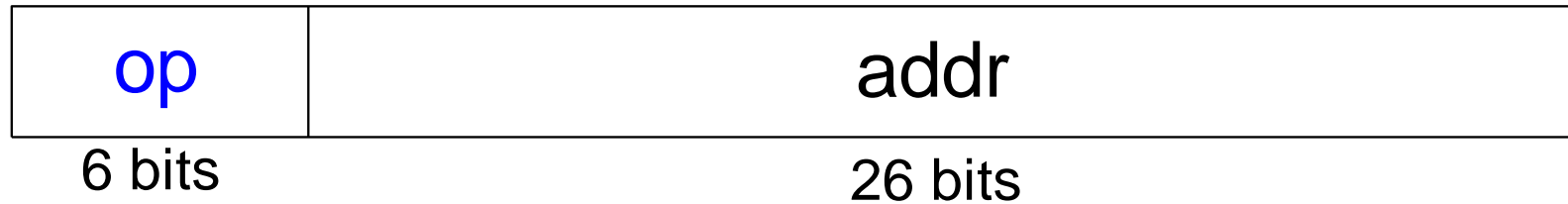

Review: Instruction Formats

R-Type

op	rs	rt	rd	shamt	funct
6 bits	5 bits	5 bits	5 bits	5 bits	6 bits

I-Type

op	rs	rt	imm
6 bits	5 bits	5 bits	16 bits

J-Type

op	addr
6 bits	26 bits



Power of the Stored Program

- 32-bit instructions & data stored in memory
- Sequence of instructions: only difference between two applications
- To run a new program:
 - No rewiring required
 - Simply store new program in memory
- Program Execution:
 - Processor *fetches* (reads) instructions from memory in sequence
 - Processor performs the specified operation

The Stored Program

Assembly Code

```
lw    $t2, 32($0)
```

```
add   $s0, $s1, $s2
```

```
addi  $t0, $s3, -12
```

```
sub   $t0, $t3, $t5
```

Machine Code

```
0x8C0A0020
```

```
0x02328020
```

```
0x2268FFF4
```

```
0x016D4022
```

Stored Program

Address	Instructions
⋮	⋮
0040000C	0 1 6 D 4 0 2 2
00400008	2 2 6 8 F F F 4
00400004	0 2 3 2 8 0 2 0
00400000	8 C 0 A 0 0 2 0 ← PC
⋮	⋮

Main Memory

Program Counter (PC): keeps track of current instruction

Interpreting Machine Code

- Start with opcode: tells how to parse rest
- If opcode all 0's
 - R-type instruction
 - Function bits tell operation
- Otherwise
 - opcode tells operation

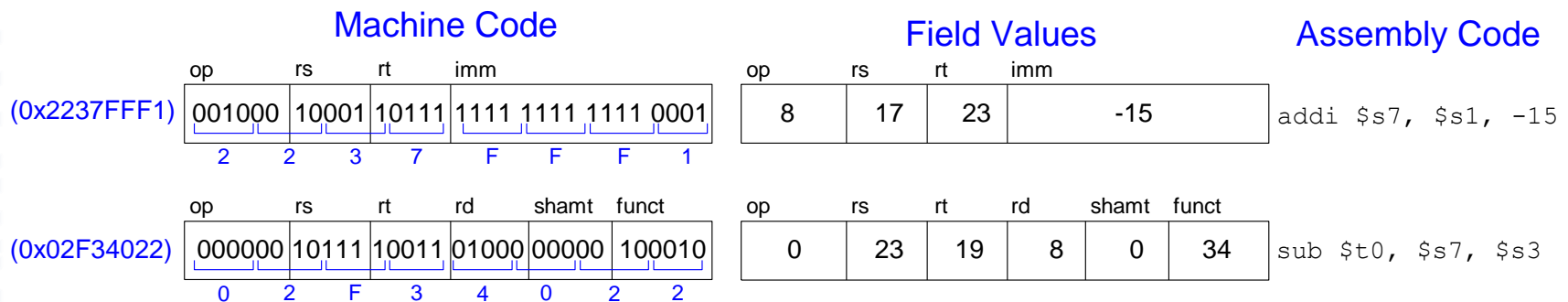

Programming

- High-level languages:
 - e.g., C, Java, Python
 - Written at higher level of abstraction
- Common high-level software constructs:
 - if/else statements
 - for loops
 - while loops
 - arrays
 - function calls

Ada Lovelace, 1815-1852

- Wrote the first computer program
- Her program calculated the Bernoulli numbers on Charles Babbage's Analytical Engine
- She was the only legitimate child of the poet Lord Byron



Logical Instructions

- **and, or, xor, nor**
 - and: useful for **masking** bits
 - Masking all but the least significant byte of a value:
 $0xF234012F \text{ AND } 0x000000FF = 0x0000002F$
 - or: useful for **combining** bit fields
 - Combine $0xF2340000$ with $0x000012BC$:
 $0xF2340000 \text{ OR } 0x000012BC = 0xF23412BC$
 - nor: useful for **inverting** bits:
 - $A \text{ NOR } \$0 = \text{NOT } A$
- **andi, ori, xori**
 - 16-bit immediate is zero-extended (*not* sign-extended)
 - nori not needed

Logical Instructions Example 1

Source Registers

\$s1	1111	1111	1111	1111	0000	0000	0000	0000
\$s2	0100	0110	1010	0001	1111	0000	1011	0111

Assembly Code

```
and $s3, $s1, $s2
or  $s4, $s1, $s2
xor $s5, $s1, $s2
nor $s6, $s1, $s2
```

Result

\$s3								
\$s4								
\$s5								
\$s6								

Logical Instructions Example 1

Source Registers

\$s1	1111	1111	1111	1111	0000	0000	0000	0000
\$s2	0100	0110	1010	0001	1111	0000	1011	0111

Assembly Code

```
and $s3, $s1, $s2
or  $s4, $s1, $s2
xor $s5, $s1, $s2
nor $s6, $s1, $s2
```

Result

\$s3	0100	0110	1010	0001	0000	0000	0000	0000
\$s4	1111	1111	1111	1111	1111	0000	1011	0111
\$s5	1011	1001	0101	1110	1111	0000	1011	0111
\$s6	0000	0000	0000	0000	0000	1111	0100	1000

Logical Instructions Example 2

Assembly Code

```

andi $s2, $s1, 0xFA34
ori  $s3, $s1, 0xFA34
xori $s4, $s1, 0xFA34

```

Source Values

\$s1	0000	0000	0000	0000	0000	0000	1111	1111
imm	0000	0000	0000	0000	1111	1010	0011	0100



 zero-extended

Result

\$s2								
\$s3								
\$s4								

Logical Instructions Example 2

Assembly Code

```
andi $s2, $s1, 0xFA34
ori  $s3, $s1, 0xFA34
xori $s4, $s1, 0xFA34
```

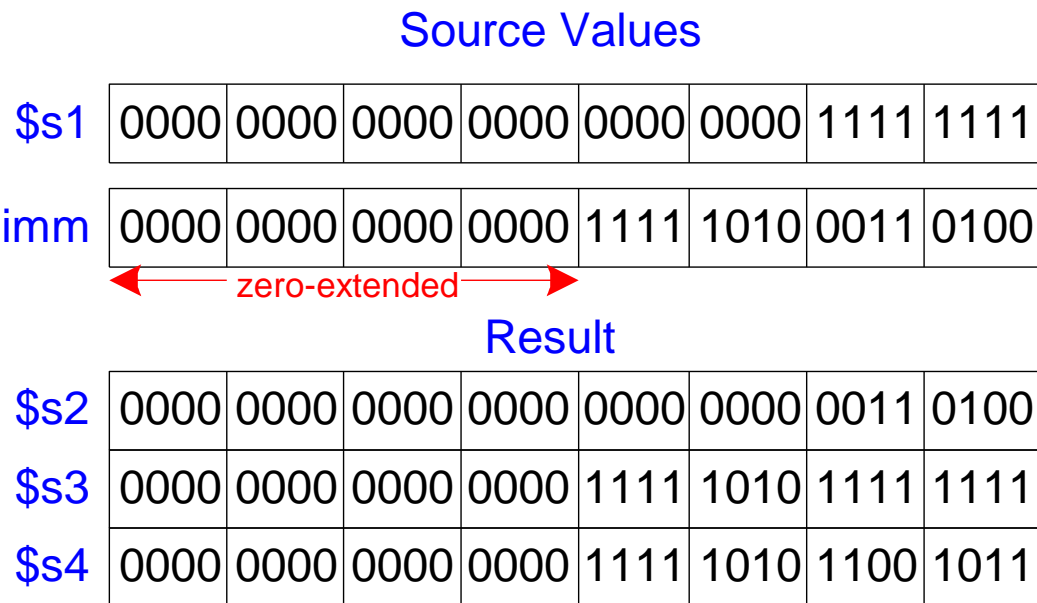

Shift Instructions

- `sll`: shift left logical
 - **Example:** `sll $t0, $t1, 5 # $t0 <= $t1 << 5`
- `srl`: shift right logical
 - **Example:** `srl $t0, $t1, 5 # $t0 <= $t1 >> 5`
- `sra`: shift right arithmetic
 - **Example:** `sra $t0, $t1, 5 # $t0 <= $t1 >>> 5`

Variable Shift Instructions

- `sllv`: shift left logical variable
 - **Example:** `sllv $t0, $t1, $t2 # $t0 <= $t1 << $t2`
- `srlv`: shift right logical variable
 - **Example:** `srlv $t0, $t1, $t2 # $t0 <= $t1 >> $t2`
- `srav`: shift right arithmetic variable
 - **Example:** `srav $t0, $t1, $t2 # $t0 <= $t1 >>> $t2`

Shift Instructions

Assembly Code

sll \$t0, \$s1, 2

srl \$s2, \$s1, 2

sra \$s3, \$s1, 2

Field Values

op	rs	rt	rd	shamt	funct
0	0	17	8	2	0
0	0	17	18	2	2
0	0	17	19	2	3

6 bits 5 bits 5 bits 5 bits 5 bits 6 bits

Machine Code

op	rs	rt	rd	shamt	funct	
000000	00000	10001	01000	00010	000000	(0x00114080)
000000	00000	10001	10010	00010	000010	(0x00119082)
000000	00000	10001	10011	00010	000011	(0x00119883)

6 bits 5 bits 5 bits 5 bits 5 bits 6 bits

Generating Constants

- 16-bit constants using `addi`:

C Code

```
// int is a 32-bit signed word  
int a = 0x4f3c;
```

MIPS assembly code

```
# $s0 = a  
addi $s0, $0, 0x4f3c
```

- 32-bit constants using load upper immediate (`lui`) and `ori`:

C Code

```
int a = 0xFEDC8765;
```

MIPS assembly code

```
# $s0 = a  
lui $s0, 0xFEDC  
ori $s0, $s0, 0x8765
```

Multiplication, Division

- Special registers: `lo`, `hi`
- 32×32 multiplication, 64 bit result
 - `mult $s0, $s1`
 - Result in `{hi, lo}`
- 32-bit division, 32-bit quotient, remainder
 - `div $s0, $s1`
 - Quotient in `lo`
 - Remainder in `hi`
- Moves from `lo/hi` special registers
 - `mflo $s2`
 - `mfhi $s3`

Branching

- Execute instructions out of sequence
- Types of branches:
 - **Conditional**
 - branch if equal (`beq`)
 - branch if not equal (`bne`)
 - **Unconditional**
 - jump (`j`)
 - jump register (`jr`)
 - jump and link (`jal`)

Review: The Stored Program

Assembly Code	Machine Code
lw \$t2, 32(\$0)	0x8C0A0020
add \$s0, \$s1, \$s2	0x02328020
addi \$t0, \$s3, -12	0x2268FFF4
sub \$t0, \$t3, \$t5	0x016D4022

Stored Program

Address	Instructions
⋮	⋮
0040000C	0 1 6 D 4 0 2 2
00400008	2 2 6 8 F F F 4
00400004	0 2 3 2 8 0 2 0
00400000	8 C 0 A 0 0 2 0 ← PC
⋮	⋮

Main Memory

Conditional Branching (beq)

MIPS assembly

```
addi $s0, $0, 4           # $s0 = 0 + 4 = 4
addi $s1, $0, 1           # $s1 = 0 + 1 = 1
sll  $s1, $s1, 2          # $s1 = 1 << 2 = 4
beq  $s0, $s1, target    # branch is taken
addi $s1, $s1, 1          # not executed
sub  $s1, $s1, $s0        # not executed

target:                    # label
add  $s1, $s1, $s0        # $s1 = 4 + 4 = 8
```

Labels indicate instruction location. They can't be reserved words and must be followed by colon (:)

The Branch Not Taken (bne)

MIPS assembly

```
addi    $s0, $0, 4           # $s0 = 0 + 4 = 4
addi    $s1, $0, 1           # $s1 = 0 + 1 = 1
sll     $s1, $s1, 2           # $s1 = 1 << 2 = 4
bne     $s0, $s1, target     # branch not taken
addi    $s1, $s1, 1           # $s1 = 4 + 1 = 5
sub     $s1, $s1, $s0         # $s1 = 5 - 4 = 1

target:
add     $s1, $s1, $s0         # $s1 = 1 + 4 = 5
```

Unconditional Branching (j)

MIPS assembly

```
addi $s0, $0, 4           # $s0 = 4
addi $s1, $0, 1           # $s1 = 1
j      target             # jump to target
sra   $s1, $s1, 2         # not executed
addi  $s1, $s1, 1         # not executed
sub   $s1, $s1, $s0       # not executed

target:
add   $s1, $s1, $s0       # $s1 = 1 + 4 = 5
```

Unconditional Branching (j r)

MIPS assembly

```
0x00002000      addi $s0, $0, 0x2010
0x00002004      jr   $s0
0x00002008      addi $s1, $0, 1
0x0000200C      sra  $s1, $s1, 2
0x00002010      lw   $s3, 44($s1)
```

j r is an **R-type** instruction.

High-Level Code Constructs

- `if` statements
- `if/else` statements
- `while` loops
- `for` loops

If Statement

C Code

```
if (i == j)
    f = g + h;

f = f - i;
```

MIPS assembly code

```
# $s0 = f, $s1 = g, $s2 = h
# $s3 = i, $s4 = j
```

If Statement

C Code

```
if (i == j)
    f = g + h;

f = f - i;
```

MIPS assembly code

```
# $s0 = f, $s1 = g, $s2 = h
# $s3 = i, $s4 = j
        bne $s3, $s4, L1
        add $s0, $s1, $s2

L1:    sub $s0, $s0, $s3
```

Assembly tests opposite case ($i \neq j$) of high-level code ($i == j$)

If/Else Statement

C Code

```
if (i == j)
    f = g + h;
else
    f = f - i;
```

MIPS assembly code

If/Else Statement

C Code

```
if (i == j)
    f = g + h;
else
    f = f - i;
```

MIPS assembly code

```
# $s0 = f, $s1 = g, $s2 = h
# $s3 = i, $s4 = j
    bne $s3, $s4, L1
    add $s0, $s1, $s2
    j    done
L1:   sub $s0, $s0, $s3
done:
```

While Loops

C Code

```
// determines the power
// of x such that 2x = 128
int pow = 1;
int x   = 0;

while (pow != 128) {
    pow = pow * 2;
    x = x + 1;
}
```

MIPS assembly code

Assembly tests for the opposite case (`pow == 128`) of the C code (`pow != 128`).

While Loops

C Code

```
// determines the power
// of x such that 2x = 128
int pow = 1;
int x   = 0;

while (pow != 128) {
    pow = pow * 2;
    x   = x + 1;
}
```

MIPS assembly code

```
# $s0 = pow, $s1 = x

        addi $s0, $0, 1
        add  $s1, $0, $0
        addi $t0, $0, 128
while:  beq  $s0, $t0, done
        sll  $s0, $s0, 1
        addi $s1, $s1, 1
        j   while
done:
```

Assembly tests for the opposite case (`pow == 128`) of the C code (`pow != 128`).

For Loops

```
for (initialization; condition; loop operation)  
    statement
```

- **initialization**: executes before the loop begins
- **condition**: is tested at the beginning of each iteration
- **loop operation**: executes at the end of each iteration
- **statement**: executes each time the condition is met

For Loops

High-level code

```
// add the numbers from 0 to 9
int sum = 0;
int i;

for (i=0; i!=10; i = i+1) {
    sum = sum + i;
}
```

MIPS assembly code

```
# $s0 = i, $s1 = sum
```

For Loops

C Code

```
// add the numbers from 0 to 9
int sum = 0;
int i;

for (i=0; i!=10; i = i+1) {
    sum = sum + i;
}
```

MIPS assembly code

For Loops

C Code

```
// add the numbers from 0 to 9
int sum = 0;
int i;

for (i=0; i!=10; i = i+1) {
    sum = sum + i;
}
```

MIPS assembly code

```
# $s0 = i, $s1 = sum
        addi $s1, $0, 0
        add  $s0, $0, $0
        addi $t0, $0, 10
for:    beq  $s0, $t0, done
        add  $s1, $s1, $s0
        addi $s0, $s0, 1
        j   for
done:
```

Less Than Comparison

C Code

```
// add the powers of 2 from 1
// to 100
int sum = 0;
int i;

for (i=1; i < 101; i = i*2) {
    sum = sum + i;
}
```

MIPS assembly code

Less Than Comparison

C Code

```
// add the powers of 2 from 1
// to 100
int sum = 0;
int i;

for (i=1; i < 101; i = i*2) {
    sum = sum + i;
}
```

MIPS assembly code

```
# $s0 = i, $s1 = sum
    addi $s1, $0, 0
    addi $s0, $0, 1
    addi $t0, $0, 101
loop: slt  $t1, $s0, $t0
      beq  $t1, $0, done
      add  $s1, $s1, $s0
      sll  $s0, $s0, 1
      j   loop
done:
```

\$t1 = 1 if $i < 101$

Arrays

- Access large amounts of similar data
- **Index**: access each element
- **Size**: number of elements

Arrays

- 5-element array
- **Base address** = 0x12348000 (address of first element, `array[0]`)
- First step in accessing an array: load base address into a register

0x12340010	array[4]
0x1234800C	array[3]
0x12348008	array[2]
0x12348004	array[1]
0x12348000	array[0]

Accessing Arrays

// C Code

```
int array[5];  
array[0] = array[0] * 2;  
array[1] = array[1] * 2;
```

Accessing Arrays

// C Code

```
int array[5];  
array[0] = array[0] * 2;  
array[1] = array[1] * 2;
```

MIPS assembly code

array base address = \$s0

```
lui   $s0, 0x1234           # 0x1234 in upper half of $S0  
ori   $s0, $s0, 0x8000     # 0x8000 in lower half of $s0  
  
lw    $t1, 0($s0)          # $t1 = array[0]  
sll   $t1, $t1, 1          # $t1 = $t1 * 2  
sw    $t1, 0($s0)          # array[0] = $t1  
  
lw    $t1, 4($s0)          # $t1 = array[1]  
sll   $t1, $t1, 1          # $t1 = $t1 * 2  
sw    $t1, 4($s0)          # array[1] = $t1
```

Arrays using For Loops

// C Code

```
int array[1000];
```

```
int i;
```

```
for (i=0; i < 1000; i = i + 1)
```

```
    array[i] = array[i] * 8;
```

MIPS assembly code

```
# $s0 = array base address, $s1 = i
```

Arrays Using For Loops

```
# MIPS assembly code
# $s0 = array base address, $s1 = i
# initialization code
    lui   $s0, 0x23B8           # $s0 = 0x23B80000
    ori   $s0, $s0, 0xF000      # $s0 = 0x23B8F000
    addi  $s1, $0, 0           # i = 0
    addi  $t2, $0, 1000        # $t2 = 1000

loop:
    slt   $t0, $s1, $t2        # i < 1000?
    beq   $t0, $0, done        # if not then done
    sll   $t0, $s1, 2           # $t0 = i * 4 (byte offset)
    add   $t0, $t0, $s0         # address of array[i]
    lw    $t1, 0($t0)          # $t1 = array[i]
    sll   $t1, $t1, 3           # $t1 = array[i] * 8
    sw    $t1, 0($t0)          # array[i] = array[i] * 8
    addi  $s1, $s1, 1          # i = i + 1
    j     loop                 # repeat

done:
```

ASCII Code

- *American Standard Code for Information Interchange*
- Each text character has unique byte value
 - For example, S = 0x53, a = 0x61, A = 0x41
 - Lower-case and upper-case differ by 0x20 (32)

Cast of Characters

#	Char	#	Char	#	Char	#	Char	#	Char	#	Char
20	space	30	0	40	@	50	P	60	'	70	p
21	!	31	1	41	A	51	Q	61	a	71	q
22	"	32	2	42	B	52	R	62	b	72	r
23	#	33	3	43	C	53	S	63	c	73	s
24	\$	34	4	44	D	54	T	64	d	74	t
25	%	35	5	45	E	55	U	65	e	75	u
26	&	36	6	46	F	56	V	66	f	76	v
27	'	37	7	47	G	57	W	67	g	77	w
28	(38	8	48	H	58	X	68	h	78	x
29)	39	9	49	I	59	Y	69	i	79	y
2A	*	3A	:	4A	J	5A	Z	6A	j	7A	z
2B	+	3B	;	4B	K	5B	[6B	k	7B	{
2C	,	3C	<	4C	L	5C	\	6C	l	7C	
2D	-	3D	=	4D	M	5D]	6D	m	7D	}
2E	.	3E	>	4E	N	5E	^	6E	n	7E	~
2F	/	3F	?	4F	O	5F	_	6F	o		

Function Calls

- **Caller:** calling function (in this case, `main`)
- **Callee:** called function (in this case, `sum`)

C Code

```
void main()
{
    int y;
    y = sum(42, 7);
    ...
}

int sum(int a, int b)
{
    return (a + b);
}
```

Function Conventions

- **Caller:**
 - passes **arguments** to callee
 - jumps to callee
- **Callee:**
 - **performs** the function
 - **returns** result to caller
 - **returns** to point of call
 - **must not overwrite** registers or memory needed by caller

MIPS Function Conventions

- **Call Function:** jump and link ($j a l$)
- **Return from function:** jump register ($j r$)
- **Arguments:** $\$a0$ – $\$a3$
- **Return value:** $\$v0$

Function Calls

C Code

```
int main() {
    simple();
    a = b + c;
}

void simple() {
    return;
}
```

MIPS assembly code

```
0x00400200 main: jal  simple
0x00400204          add  $s0, $s1, $s2
...

0x00401020 simple: jr  $ra
```

void means that `simple` doesn't return a value

Function Calls

C Code

```
int main() {
    simple();
    a = b + c;
}

void simple() {
    return;
}
```

MIPS assembly code

```
0x00400200 main: jal simple
0x00400204          add $s0, $s1, $s2
...

0x00401020 simple: jr $ra
```

jal: jumps to simple
 $\$ra = PC + 4 = 0x00400204$

jr \$ra: jumps to address in $\$ra$ (0x00400204)

Input Arguments & Return Value

MIPS conventions:

- Argument values: $\$a0 - \$a3$
- Return value: $\$v0$

Input Arguments & Return Value

C Code

```
int main()
{
    int y;
    ...
    y = diffofsums(2, 3, 4, 5); // 4 arguments
    ...
}

int diffofsums(int f, int g, int h, int i)
{
    int result;
    result = (f + g) - (h + i);
    return result; // return value
}
```

Input Arguments & Return Value

MIPS assembly code

```
# $s0 = y

main:
    ...
    addi $a0, $0, 2    # argument 0 = 2
    addi $a1, $0, 3    # argument 1 = 3
    addi $a2, $0, 4    # argument 2 = 4
    addi $a3, $0, 5    # argument 3 = 5
    jal  diffofsums    # call Function
    add  $s0, $v0, $0   # y = returned value
    ...

# $s0 = result
diffofsums:
    add $t0, $a0, $a1  # $t0 = f + g
    add $t1, $a2, $a3  # $t1 = h + i
    sub $s0, $t0, $t1  # result = (f + g) - (h + i)
    add $v0, $s0, $0   # put return value in $v0
    jr  $ra            # return to caller
```

Input Arguments & Return Value

MIPS assembly code

```
# $s0 = result
diffofsums:
    add $t0, $a0, $a1    # $t0 = f + g
    add $t1, $a2, $a3    # $t1 = h + i
    sub $s0, $t0, $t1    # result = (f + g) - (h + i)
    add $v0, $s0, $0     # put return value in $v0
    jr  $ra              # return to caller
```

- diffofsums overwrote 3 registers: \$t0, \$t1, \$s0
- diffofsums can use *stack* to temporarily store registers

The Stack

- Memory used to temporarily save variables
- Like stack of dishes, last-in-first-out (LIFO) queue
- ***Expands:*** uses more memory when more space needed
- ***Contracts:*** uses less memory when the space is no longer needed



The Stack

- Grows down (from higher to lower memory addresses)
- Stack pointer: $\$sp$ points to top of the stack

Address	Data		Address	Data	
7FFFFFFC	12345678	← $\$sp$	7FFFFFFC	12345678	
7FFFFFF8			7FFFFFF8	AABBCCDD	
7FFFFFF4			7FFFFFF4	11223344	← $\$sp$
7FFFFFF0			7FFFFFF0		
⋮	⋮		⋮	⋮	
⋮	⋮		⋮	⋮	
⋮	⋮		⋮	⋮	

How Functions use the Stack

- Called functions must have no unintended side effects
- But `diffofsums` overwrites 3 registers: `$t0`, `$t1`, `$s0`

```
# MIPS assembly
```

```
# $s0 = result
```

```
diffofsums:
```

```
add $t0, $a0, $a1 # $t0 = f + g
```

```
add $t1, $a2, $a3 # $t1 = h + i
```

```
sub $s0, $t0, $t1 # result = (f + g) - (h + i)
```

```
add $v0, $s0, $0 # put return value in $v0
```

```
jr $ra # return to caller
```

Storing Register Values on the Stack

```
# $s0 = result
diffofsums:
    addi $sp, $sp, -12    # make space on stack
                          # to store 3 registers

    sw   $s0, 8($sp)     # save $s0 on stack
    sw   $t0, 4($sp)     # save $t0 on stack
    sw   $t1, 0($sp)     # save $t1 on stack

    add  $t0, $a0, $a1    # $t0 = f + g
    add  $t1, $a2, $a3    # $t1 = h + i
    sub  $s0, $t0, $t1    # result = (f + g) - (h + i)
    add  $v0, $s0, $0     # put return value in $v0

    lw   $t1, 0($sp)     # restore $t1 from stack
    lw   $t0, 4($sp)     # restore $t0 from stack
    lw   $s0, 8($sp)     # restore $s0 from stack

    addi $sp, $sp, 12    # deallocate stack space
    jr   $ra             # return to caller
```



The stack during diffofsums Call

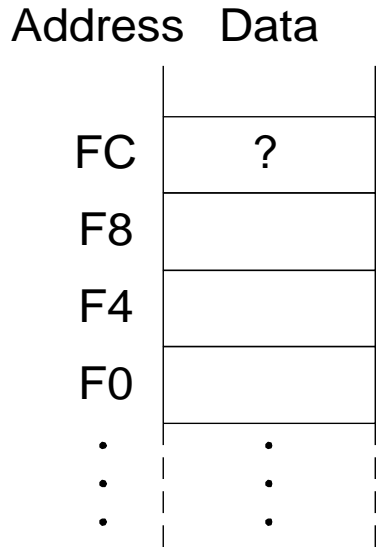

(a)

← \$sp

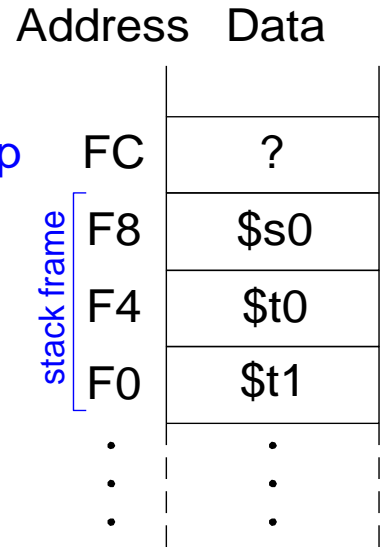

(b)

stack frame

← \$sp

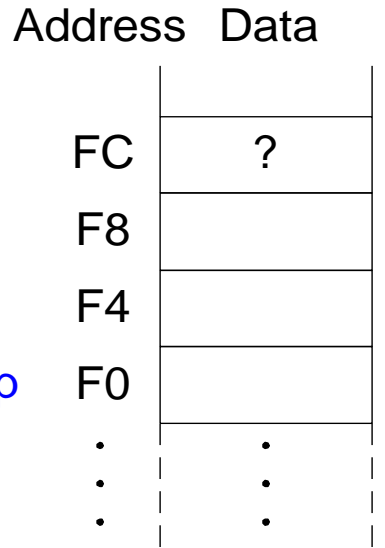

(c)

← \$sp



Registers

Preserved <i>Callee-Saved</i>	Nonpreserved <i>Caller-Saved</i>
$\\$s0-\\$s7$	$\\$t0-\\$t9$
$\\$ra$	$\\$a0-\\$a3$
$\\$sp$	$\\$v0-\\$v1$
stack above $\\$sp$	stack below $\\$sp$

Multiple Function Calls

```
proc1:
    addi $sp, $sp, -4    # make space on stack
    sw   $ra, 0($sp)    # save $ra on stack
    jal  proc2
    ...
    lw   $ra, 0($sp)    # restore $s0 from stack
    addi $sp, $sp, 4    # deallocate stack space
    jr   $ra            # return to caller
```

Storing Saved Registers on the Stack

```
# $s0 = result
diffofsums:
    addi $sp, $sp, -4    # make space on stack to
                        # store one register
    sw   $s0, 0($sp)    # save $s0 on stack
                        # no need to save $t0 or $t1

    add  $t0, $a0, $a1   # $t0 = f + g
    add  $t1, $a2, $a3   # $t1 = h + i
    sub  $s0, $t0, $t1   # result = (f + g) - (h + i)
    add  $v0, $s0, $0    # put return value in $v0
    lw   $s0, 0($sp)    # restore $s0 from stack
    addi $sp, $sp, 4    # deallocate stack space
    jr   $ra            # return to caller
```



Recursive Function Call

High-level code

```
int factorial(int n) {  
    if (n <= 1)  
        return 1;  
    else  
        return (n * factorial(n-1));  
}
```

Recursive Function Call

MIPS assembly code

Recursive Function Call

MIPS assembly code

```
0x90 factorial: addi $sp, $sp, -8 # make room
0x94           sw   $a0, 4($sp) # store $a0
0x98           sw   $ra, 0($sp) # store $ra
0x9C           addi $t0, $0, 2
0xA0           slt  $t0, $a0, $t0 # a <= 1 ?
0xA4           beq  $t0, $0, else # no: go to else
0xA8           addi $v0, $0, 1 # yes: return 1
0xAC           addi $sp, $sp, 8 # restore $sp
0xB0           jr   $ra # return
0xB4           else: addi $a0, $a0, -1 # n = n - 1
0xB8           jal  factorial # recursive call
0xBC           lw   $ra, 0($sp) # restore $ra
0xC0           lw   $a0, 4($sp) # restore $a0
0xC4           addi $sp, $sp, 8 # restore $sp
0xC8           mul  $v0, $a0, $v0 # n * factorial(n-1)
0xCC           jr   $ra # return
```

Stack During Recursive Call

Address Data

FC	
F8	
F4	
F0	
EC	
E8	
E4	
E0	
DC	

← \$sp

Address Data

FC	
F8	\$a0 (0x3)
F4	\$ra
F0	\$a0 (0x2)
EC	\$ra (0xBC)
E8	\$a0 (0x1)
E4	\$ra (0xBC)
E0	
DC	

← \$sp

← \$sp

← \$sp

← \$sp

Address Data

FC	
F8	\$a0 (0x3)
F4	\$ra
F0	\$a0 (0x2)
EC	\$ra (0xBC)
E8	\$a0 (0x1)
E4	\$ra (0xBC)
E0	
DC	

← \$sp \$v0 = 6

← \$sp \$a0 = 3
\$v0 = 3 x 2

← \$sp \$a0 = 2
\$v0 = 2 x 1

← \$sp \$a0 = 1
\$v0 = 1 x 1



Function Call Summary

- **Caller**
 - Put arguments in $\$a0-\$a3$
 - Save any needed registers ($\$ra$, maybe $\$t0-t9$)
 - `jal callee`
 - Restore registers
 - Look for result in $\$v0$
- **Callee**
 - Save registers that might be disturbed ($\$s0-\$s7$)
 - Perform function
 - Put result in $\$v0$
 - Restore registers
 - `jr $ra`

Addressing Modes

How do we address the operands?

- Register Only
- Immediate
- Base Addressing
- PC-Relative
- Pseudo Direct

Addressing Modes

Register Only

- Operands found in registers
 - **Example:** `add $s0, $t2, $t3`
 - **Example:** `sub $t8, $s1, $0`

Immediate

- 16-bit immediate used as an operand
 - **Example:** `addi $s4, $t5, -73`
 - **Example:** `ori $t3, $t7, 0xFF`

Addressing Modes

Base Addressing

- Address of operand is:

base address + sign-extended immediate

– **Example:** `lw $s4, 72($0)`

- address = $\$0 + 72$

– **Example:** `sw $t2, -25($t1)`

- address = $\$t1 - 25$

Addressing Modes

PC-Relative Addressing

```

0x10      beq    $t0, $0, else
0x14      addi   $v0, $0, 1
0x18      addi   $sp, $sp, i
0x1C      jr     $ra
0x20      else:  addi   $a0, $a0, -1
0x24      jal    factorial
  
```

Assembly Code

Field Values

	op	rs	rt	imm	
beq \$t0, \$0, else	4	8	0	3	
(beq \$t0, \$0, 3)	6 bits	5 bits	5 bits	5 bits	6 bits

Addressing Modes

Pseudo-direct Addressing

```

0x0040005C      jal    sum
...
0x004000A0  sum:  add    $v0, $a0, $a1
    
```

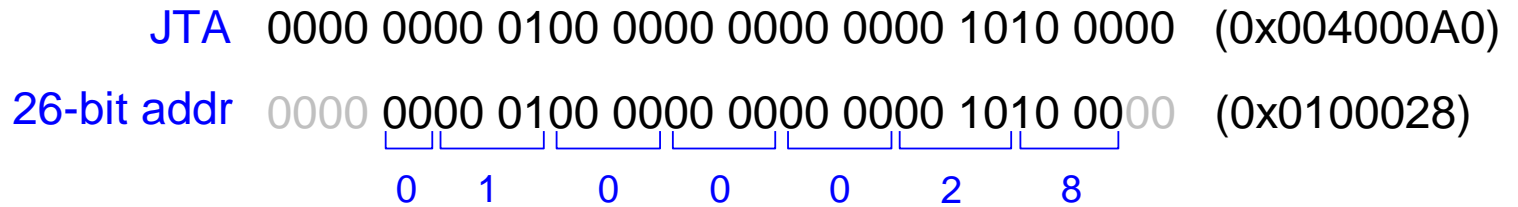

Field Values

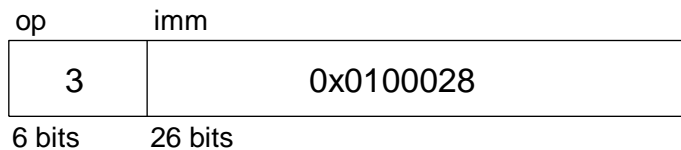

Machine Code

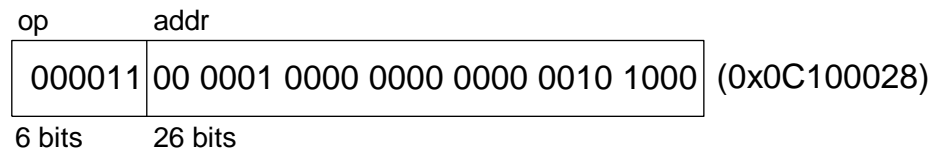

How to Compile & Run a Program

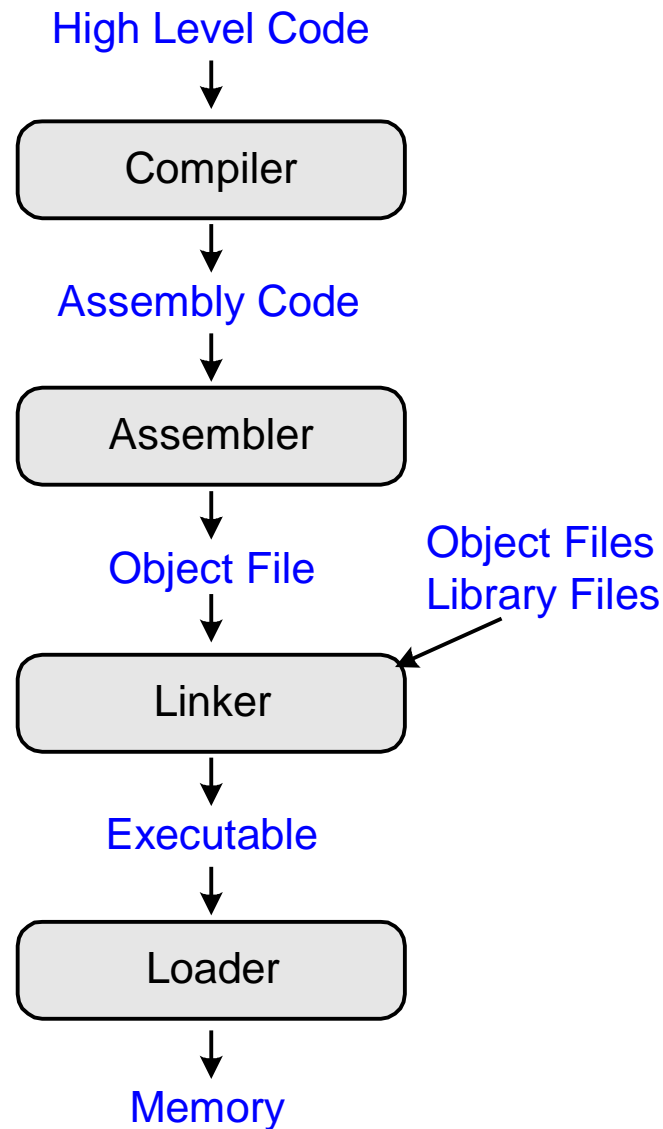

Grace Hopper, 1906-1992

- Graduated from Yale University with a Ph.D. in mathematics
- Developed first compiler
- Helped develop the COBOL programming language
- Highly awarded naval officer
- Received World War II Victory Medal and National Defense Service Medal, among others



What is Stored in Memory?

- Instructions (also called *text*)
- Data
 - Global/static: allocated before program begins
 - Dynamic: allocated within program
- How big is memory?
 - At most $2^{32} = 4$ gigabytes (4 GB)
 - From address 0x00000000 to 0xFFFFFFFF

MIPS Memory Map

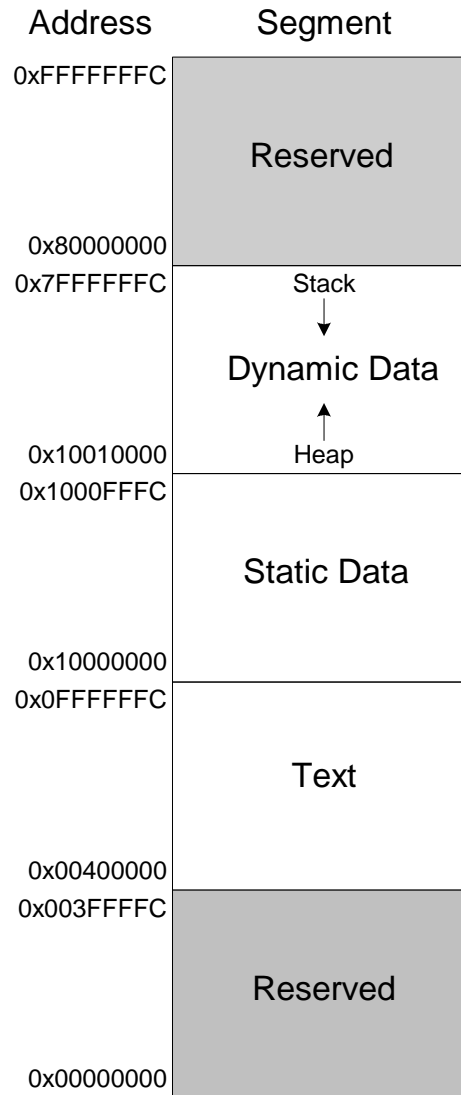

Example Program: C Code

```
int f, g, y; // global variables
```

```
int main(void)
```

```
{
```

```
    f = 2;
```

```
    g = 3;
```

```
    y = sum(f, g);
```

```
    return y;
```

```
}
```

```
int sum(int a, int b) {
```

```
    return (a + b);
```

```
}
```

Example Program: MIPS Assembly

```
int f, g, y; // global
int main(void)
{
    f = 2;
    g = 3;
    y = sum(f, g);
    return y;
}

int sum(int a, int b) {
    return (a + b);
}

.data
f:
g:
y:
.text
main:
    addi $sp, $sp, -4    # stack frame
    sw   $ra, 0($sp)    # store $ra
    addi $a0, $0, 2     # $a0 = 2
    sw   $a0, f         # f = 2
    addi $a1, $0, 3     # $a1 = 3
    sw   $a1, g         # g = 3
    jal  sum            # call sum
    sw   $v0, y         # y = sum()
    lw   $ra, 0($sp)    # restore $ra
    addi $sp, $sp, 4    # restore $sp
    jr   $ra           # return to OS
sum:
    add  $v0, $a0, $a1  # $v0 = a + b
    jr   $ra           # return
```



Example Program: Symbol Table

Symbol	Address

Example Program: Symbol Table

Symbol	Address
f	0x10000000
g	0x10000004
y	0x10000008
main	0x00400000
sum	0x0040002C

Example Program: Executable

Executable file header	Text Size	Data Size
	0x34 (52 bytes)	0xC (12 bytes)
Text segment	Address	Instruction
	0x00400000	0x23BDFFFC
	0x00400004	0xAFBF0000
	0x00400008	0x20040002
	0x0040000C	0xAF848000
	0x00400010	0x20050003
	0x00400014	0xAF858004
	0x00400018	0x0C10000B
	0x0040001C	0xAF828008
	0x00400020	0x8FBF0000
	0x00400024	0x23BD0004
	0x00400028	0x03E00008
	0x0040002C	0x00851020
	0x00400030	0x03E00008
Data segment	Address	Data
	0x10000000	f
	0x10000004	g
	0x10000008	y

```

addi $sp, $sp, -4
sw  $ra, 0 ($sp)
addi $a0, $0, 2
sw  $a0, 0x8000 ($gp)
addi $a1, $0, 3
sw  $a1, 0x8004 ($gp)
jal  0x0040002C
sw  $v0, 0x8008 ($gp)
lw  $ra, 0 ($sp)
addi $sp, $sp, -4
jr  $ra
add $v0, $a0, $a1
jr  $ra

```

Example Program: In Memory

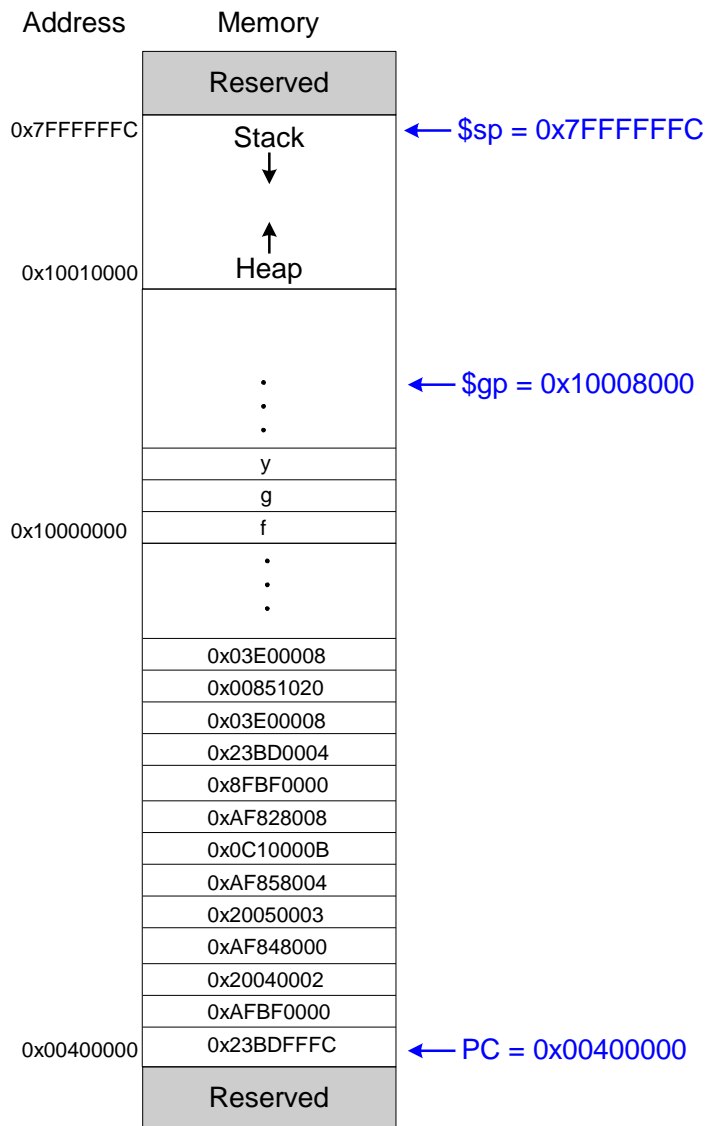

Odds & Ends

- Pseudoinstructions
- Exceptions
- Signed and unsigned instructions
- Floating-point instructions

Pseudoinstructions

Pseudoinstruction	MIPS Instructions
<code>li \$s0, 0x1234AA77</code>	<code>lui \$s0, 0x1234</code> <code>ori \$s0, 0xAA77</code>
<code>clear \$t0</code>	<code>add \$t0, \$0, \$0</code>
<code>move \$s1, \$s2</code>	<code>add \$s2, \$s1, \$0</code>
<code>nop</code>	<code>sll \$0, \$0, 0</code>

Exceptions

- Unscheduled function call to *exception handler*
- Caused by:
 - Hardware, also called an *interrupt*, e.g., keyboard
 - Software, also called *traps*, e.g., undefined instruction
- When exception occurs, the processor:
 - Records the cause of the exception
 - Jumps to exception handler (at instruction address 0x80000180)
 - Returns to program

Exception Registers

- Not part of register file
 - **Cause**: Records cause of exception
 - **EPC** (Exception PC): Records PC where exception occurred
- EPC and Cause: part of Coprocessor 0
- Move from Coprocessor 0
 - `mfc0 $t0, EPC`
 - Moves contents of EPC into `$t0`

Exception Causes

Exception	Cause
Hardware Interrupt	0x00000000
System Call	0x00000020
Breakpoint / Divide by 0	0x00000024
Undefined Instruction	0x00000028
Arithmetic Overflow	0x00000030

Exception Flow

- Processor saves cause and exception PC in Cause and EPC
- Processor jumps to exception handler (0x80000180)
- Exception handler:
 - Saves registers on stack
 - Reads Cause register

```
mfc0 $t0, Cause
```
 - Handles exception
 - Restores registers
 - Returns to program

```
mfc0 $k0, EPC
```

```
jr $k0
```

Signed & Unsigned Instructions

- Addition and subtraction
- Multiplication and division
- Set less than

Addition & Subtraction

- **Signed:** `add`, `addi`, `sub`
 - Same operation as unsigned versions
 - But processor takes exception on overflow
- **Unsigned:** `addu`, `addiu`, `subu`
 - Doesn't take exception on overflow

Note: `addiu` sign-extends the immediate

Multiplication & Division

- **Signed:** `mult`, `div`
- **Unsigned:** `multu`, `divu`

Set Less Than

- **Signed:** `slt`, `slti`
- **Unsigned:** `sltu`, `sltiu`

Note: `sltiu` sign-extends the immediate before comparing it to the register

Loads

- **Signed:**
 - Sign-extends to create 32-bit value to load into register
 - Load halfword: `lh`
 - Load byte: `lb`
- **Unsigned:**
 - Zero-extends to create 32-bit value
 - Load halfword unsigned: `lhu`
 - Load byte: `lbu`

Floating-Point Instructions

- Floating-point coprocessor (Coprocessor 1)
- 32 32-bit floating-point registers ($\$f0$ - $\$f31$)
- Double-precision values held in two floating point registers
 - e.g., $\$f0$ and $\$f1$, $\$f2$ and $\$f3$, etc.
 - Double-precision floating point registers: $\$f0$, $\$f2$, $\$f4$, etc.

Floating-Point Instructions

Name	Register Number	Usage
\$fv0 - \$fv1	0, 2	return values
\$ft0 - \$ft3	4, 6, 8, 10	temporary variables
\$fa0 - \$fa1	12, 14	Function arguments
\$ft4 - \$ft8	16, 18	temporary variables
\$fs0 - \$fs5	20, 22, 24, 26, 28, 30	saved variables

F-Type Instruction Format

- Opcode = 17 (010001_2)
- Single-precision:
 - cop = 16 (010000_2)
 - add.s, sub.s, div.s, neg.s, abs.s, etc.
- Double-precision:
 - cop = 17 (010001_2)
 - add.d, sub.d, div.d, neg.d, abs.d, etc.
- 3 register operands:
 - fs, ft: source operands
 - fd: destination operands

F-Type



Floating-Point Branches

- Set/clear condition flag: `fpcond`
 - Equality: `c.seq.s`, `c.seq.d`
 - Less than: `c.lt.s`, `c.lt.d`
 - Less than or equal: `c.le.s`, `c.le.d`
- Conditional branch
 - `bclf`: branches if `fpcond` is FALSE
 - `bclt`: branches if `fpcond` is TRUE
- Loads and stores
 - `lwc1`: `lwc1 $ft1, 42($s1)`
 - `swc1`: `swc1 $fs2, 17($sp)`

Looking Ahead

Microarchitecture – building MIPS processor in hardware

Bring colored pencils